

# the Green Vacuum®

Automated Drain System



Model: TGV11S

## Instruction Manual

Please read this before returning this product for any reason.



the Green Vacuum®

If you have experienced any problems or have any questions with the purchase of the Green Vacuum®, please go to:

[www.thegreenvacuum.com](http://www.thegreenvacuum.com)  
for quick answers 24 hours a day.

If you are not able to find the specific answer to your question and would like to speak with an agent, or do not have access to the internet, please call

**1.855.674.0413**

from 9:00am to 05:00pm EST - Monday through Friday

For more information on all the products we offer, please go to  
[www.thegreenvacuum.com/store](http://www.thegreenvacuum.com/store)

**Save this manual for future reference.**



## IMPORTANT SAFEGUARDS

When using this unit, basic safety precautions should always be followed, including the following:

**PLEASE READ AND UNDERSTAND ALL INSTRUCTIONS BEFORE USING THE UNIT.**

### SAFETY GUIDELINES – DEFINITIONS

It is important for you to read and understand this manual. The information it contains relates to protecting YOUR SAFETY and PREVENTING PROBLEMS. The symbols below are used to help you recognize this information.

 **DANGER:** Indicates an imminently hazardous situation which, if not avoided, will result in death or serious injury.

 **WARNING:** Indicates a potentially hazardous situation which, if not avoided, could result in death or serious injury.

 **CAUTION:** Indicates a potentially hazardous situation which, if not avoided, may result in minor or moderate injury.

**CAUTION:** Used without the safety alert symbol indicates potentially hazardous situation which, if not avoided, may result in property damage.

 **WARNING: Warning to Minors**

1. Keep children away from the unit when both operable and inoperable.
2. Close supervision is necessary when the unit is operable by or near children. Do not allow to be used as a toy.
3. Do not let children play with or handle any component parts and packaging materials in the box as these can serve as a choking hazard. Particularly, do not let children handle any plastic bags, Styrofoam, small hardware such as screws or wires, and any other small items located in the box.
4. Keep children away from the battery.

 **WARNING: Shock Hazard and Fire Hazard**

1. Do not operate in the presence of flammable fumes, liquids, or explosives.
2. Do not operate the unit with a damaged cord or solar module.
3. Do not handle the unit with wet hands, in standing water, or during inclement weather.
4. Always wear safety goggles and gloves when handling the unit or changing the battery.
5. Do not attempt to charge this product with any other charger other than the solar module provided with the unit.
6. When installing or changing the battery always do so in a well-ventilated area free of combustible materials, gasoline, or solvent vapors.
7. Never install or change the battery during wet or rainy conditions or in a location where it is wet or near excess liquids.
8. Do not allow wires connected to battery to come into contact with other metal parts as this could lead to a spark, electrical shock, or burns.
9. Do not allow wires connecting to battery to touch metal on your person as that could lead to a spark, electrical shock, or burns.

 **WARNING: IMPORTANT SAFEGUARDS:**

1. Do not use the unit in a manner that is contradictory or outside the scope of the intended use or purpose for this product. This product is intended to be used as a device to suction the HVAC condensation line, pipe and/or drain that connects an interior home air-conditioning unit to the exterior of the home for drainage of condensation.
2. Never attempt to operate the unit with missing or malfunctioning components or in a manner other than its intended purpose which could cause unsafe or hazardous conditions resulting in serious injury or death.
3. Do not allow fluids to enter the unit or land on exposed components when lid is removed.
4. Replace unit if it was damaged, flooded, or submerged.
5. If you believe the unit was compromised with water after extreme rain or flooding, do not attempt to operate the unit.
6. Use extreme caution when operating unit without protective lid in place.
7. When installing unit in a desired location, make sure it is properly attached to the wall or another secure structure to avoid the unit coming loose, falling and/or cause serious harm or injury to oneself or others; and possibly voiding the warranty due to negligence.
8. Keep hair, jewelry, loose clothing, and all body parts away from moving components or suction areas.
9. Do not insert any object into the unit for any reason while the unit is operable or inoperable.
10. Do not put any objects into unit openings.
11. Do not block any openings and do not block air flow through the unit.
12. Do not place your head, hands, feet, or any other body part near any air vents when unit is operable as there is a possibility of injury from moving components.
13. Do not place your head, hands, feet, or any other body part near any air vents when unit is operable as sometimes there is a possibility of debris being discharged from the pipes.
14. If the unit malfunctions or ceases to operate according to the specifications stated within this manual, do not attempt to repair the unit yourself. Please contact The Green Vacuum, LLC customer service line at **855-674-0413** or send an email to customer service at **support@thegreenvacuum.com**

**CAUTION: IMPORTANT SAFEGUARDS:**

1. The drain line should be professionally cleaned and cleared of any blockages or debris prior to installation of the unit.
2. Consult state and local regulations and ordinances prior to installing the unit for additional installation requirements.
3. Do not use this product for commercial grade air conditioning units. It is only intended for residential units.
4. Unit is not to be installed on a drain line exceeding Thirty (30) feet in length.
5. Unit is not to be installed in a manner or location where the discharge would have to pull water upward.
6. The unit is not designed to replace the P-Trap. Do not remove existing P-trap when installing the unit.
7. This unit is designed to release 1 to 2 ounces of water after each suction cycle into the P-trap included with this unit, to avoid negative pressure in the drain line.
8. Do not install the unit in a location subjected to high pressure water.
9. Do not flush the drain line with any cleaners, solvents, or other similar liquids with the unit installed.
10. Do not place the unit in a location above the elevation of the air handler as this will not allow the unit to drain properly.
11. Keep free of dust, dirt, lint, leaves, mold, and hair.
12. Do not program the unit timer to run longer than two (2) minutes per day.

 **WARNING: Warnings Related to Acid Battery**

1. When replacing the battery, please contact The Green Vacuum, LLC to acquire a replacement. The replacement battery must be of equal size, rating, and voltage.
2. Hazardous exposure may occur when the product is heated, oxidized or otherwise processed, damaged or subjected to misuse.
3. Follow all instructions carefully when installing, servicing and using the battery.
4. Under normal conditions of use, no health effects are expected. Contents of an open battery can cause respiratory irritation for people with sensitivities or weakened respiratory systems.
5. If any fumes originating from the battery are inhaled go to a well-ventilated area and breathe in fresh air. If you suffer from respiratory problems or do not improve after breathing fresh air seek medical attention immediately.
6. If contents of battery come into contact with skin, it can cause severe burns. Flush skin with water and soap and seek medical attention immediately.
7. If contents of battery come into contact with eyes, it can cause severe burns. Flush eyes with running water for several minutes and seek medical attention immediately.
8. Lead ingestion may cause abdominal pain, nausea, vomiting, diarrhea and severe cramping.
9. In the event of battery breakage, exposure to sulphuric acid and lead may occur. During high rate charges or overcharging, acid mist may occur.
10. Use standard lead-acid battery practices. Do not wear metallic jewelry when working with batteries. Use non-conductive tools only. Discharge static electricity prior to working on a battery, and maintain eyewash, fire extinguisher and an emergency communication device in the work area.
11. Broken batteries may result in small amounts of spilled electrolyte. Electrolyte is a corrosive, nonflammable liquid.
12. Lead Acid Batteries may catch fire if unsealed or malfunctioning.
13. In the event of a fire cause by the battery use CO<sub>2</sub> or dry powder extinguishing agents for best results in extinguishing the fire.
14. Keep away from heat and sources of ignition. Wash hands thoroughly after use. Do not use organic solvents; use only manufacturer recommended cleaners on the batteries. Avoid sparks. Do not remove vent caps. Do not double stack industrial batteries, it may cause damage.
15. Spent lead acid batteries (EWC 160601) are subject to regulation of the EU Battery Directive and its adoptions into national legislation on the composition and end of life management of batteries. Spent Lead Acid batteries are recycled in lead refineries (secondary lead smelters). The components of a spent Lead Acid battery are recycled or reprocessed. At the points of sale, the manufacturers and importers of batteries, respectively the metal dealers take back spent batteries, and render them to the secondary lead smelters for processing. To simplify the collection and recycling or reprocessing process spent Lead Acid batteries must not be mixed with other batteries. By no means may the electrolyte (diluted sulphuric acid) be emptied in an inexpert manner. This process is to be carried out by the processing companies only.
16. Consult local and state ordinances and/or regulations prior to disposing the battery.

 **WARNING: Battery removal and disposal**





1. When the battery no longer holds a charge, it should be removed from the unit and recycled. battery must not be incinerated or composted.
2. The battery can be taken for disposal to an Authorized Service Center. Some local retailers are also participating in a national recycling program. If you bring the battery to an Authorized Service Center, the Center will arrange to recycle old batteries, or contact your local municipality for proper disposal instructions in your city/town.
3. The Green Vacuum is a registered participant in:



## SAVE THESE INSTRUCTIONS

### Symbols

*The label on your tool may include the following symbols.*

The symbols and their definitions are as follows:			
V	Volts	A	Amperes
Hz	Hertz	W	Watts
min	Minutes		Alternating Current
---	Direct Current	n <sub>0</sub>	No load speed
	Class I Construction (grounded)		Earthing Terminal
	Class II Construction (double insulated)		Safety Alert Symbol
			.../min or rpm...revolutions or reciprocation per minute

**Save this manual for future reference.**



## PRODUCT FEATURES

### TGV11S

The drain line should be professionally cleaned and cleared of any blockages or debris prior to installation of the unit.

FIGURE A

- 1 Solar module\*
- 2 Brackets\*
- 3 Inlet port
- 4 Cover\*
- 5 Outlet port
- 6 P-trap\*

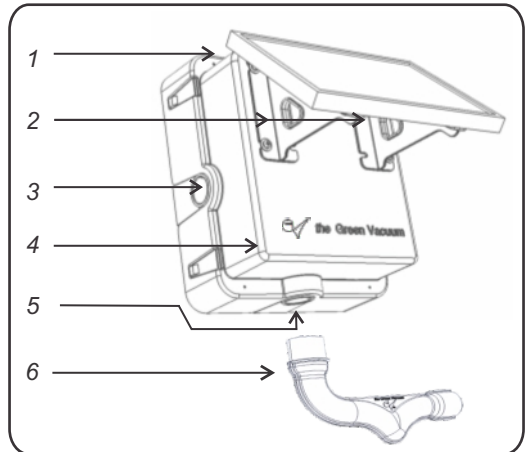

\* Cover, Solar module, brackets and P-trap have some assembly required

FIGURE B

- 1 Wall mounting holes
- 2 Timer
- 3 Thermostat
- 4 Fuse
- 5 Solar module cable inlet
- 6 Battery (SLA)
- 7 Pump
- 8 Solar module cable holder
- 9 Base
- 10 Replace battery alert

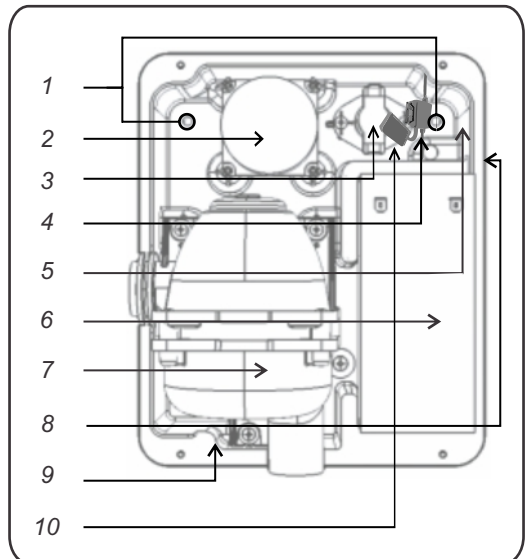



## PRODUCT FEATURES

### TGV11S

#### Assembly

Always keep the **TIMER** on **AUTO** mode to ensure proper functionality of the programs.

#### Wall Mounting

- Remove battery from base.
- Locate the Green Vacuum base. See Figure B.
- At the top of the base, locate the two pre-drilled holes. See Figure C.

C1

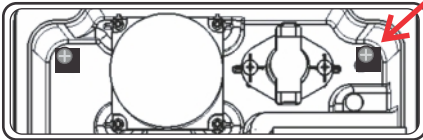
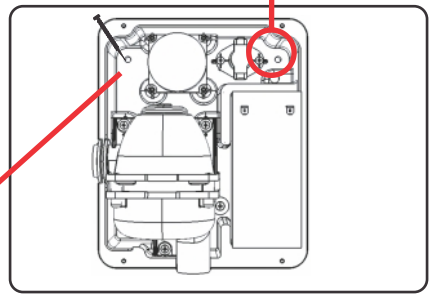

FIGURE C



- Measure and mark on the wall where you wish to install the Green Vacuum. Within reach of a drain line, place the unit below the level of the AC handler drain inside the house to allow condensation to drain while the unit is inoperable.
- Once the desired location is chosen and the area is marked, using a concrete drill bit, (3/16 x 3½) drill holes into the wall where screws will be inserted.
- Place the unit against the wall and begin tightening the included screws with rubber washers until the unit is completely secure.

#### Installing the Pipe

- Plug the ¾ inch end of the drain line extending from your AC unit into the inlet port side of the unit. See figure D.
- If the drain pipe is ½" or 1" inch diameter, you will need an adapter (NOT INCLUDED) to allow the pipe to fit properly in the unit. Otherwise, the unit will not work as intended.

FIGURE D

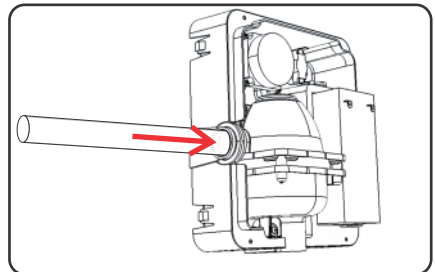

\* We recommend checking the unit once a year to assess proper function.  
Refer to troubleshooting page 11



## PRODUCT FEATURES

### TGV11S

#### Assembly

Always keep the **TIMER** on **AUTO** mode to ensure proper functionality of the programs.

#### Connecting The Battery

Before connecting the battery, make sure that all precautions stated in the warnings section of this Manual have been adhered to.

- Remove the plastic covering of the battery connector port.
- #Locate the cable wires in the unit. There should be a black wire ( - ) NEGATIVE and a red wire ( + ) POSITIVE
- #Connect the red wire to the positive red port. Connect the black wire to the negative black port. See Figure E.
- #Unit will beep when battery needs replacement. Follow all steps when replacing the battery.

FIGURE E

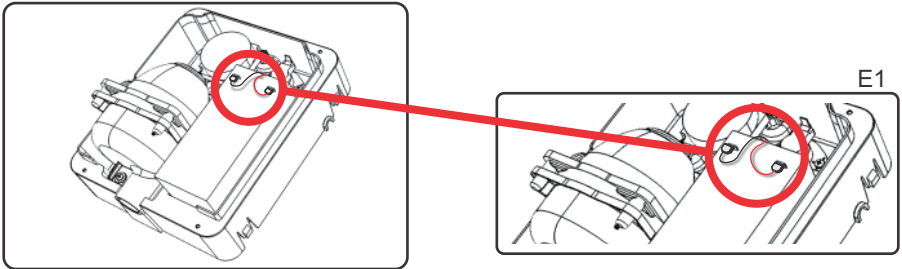

#### Replacing The Fuse

To change the fuse, remove cover and unplug the battery. Open the fuse cap shown on figure F. Remove the old fuse by pulling out and replace with new one, included with the unit.

Once done, close the fuse housing cap reconnect the battery as shown on Fig E. Proceed to lock the cover shown on figure I on page 8.

FIGURE F

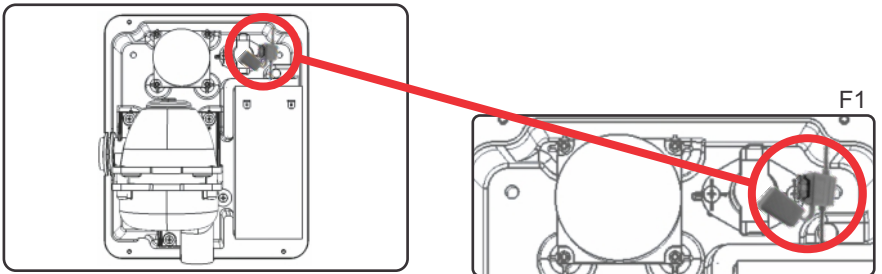

\* We recommend checking the unit once a year to assess proper function.  
Refer to troubleshooting page 11





## PRODUCT FEATURES

### TGV11S

#### Assembly

Always keep the **TIMER** on **AUTO** mode to ensure proper functionality of the programs.

#### Mounting The Brackets

Place the brackets in the position shown on figure G. Tighten them down with the 4 included screws, using a Phillip screwdriver.

FIGURE G

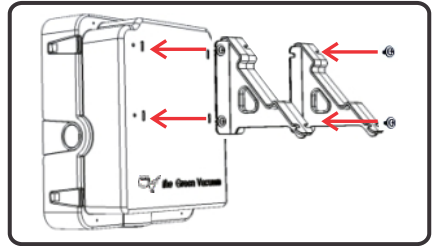

#### Mounting The Solar Module

Hook the solar module to the top of the brackets. Using the 2 included screws secure the solar module to the bottom of the brackets, as shown on figure H.

FIGURE H

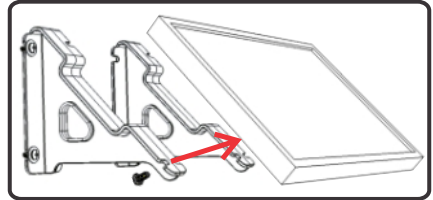

#### Locking the cover

To lock the cover, firmly press down on the cover until all four corners click into the lock position.

As shown in figure I, use the three included screws and rubber washers to secure the cover in place.

FIGURE I

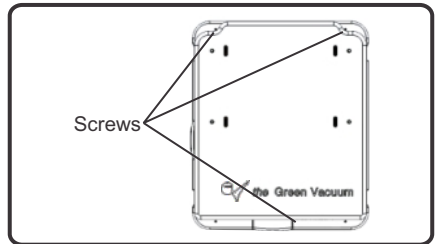

#### Mounting The P-trap

Choose the angle which you would like to install the P-trap as shown on figure J. Glue the P-trap with ABS plastic glue only. (Glue not included)

Insert P-trap provided with this unit into the outlet port firmly and choose desired angle as shown on figure J.

FIGURE J

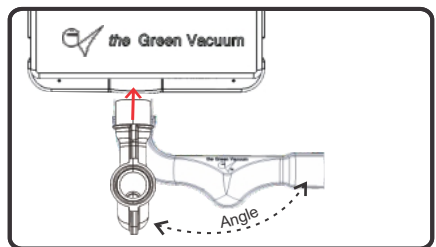

\* We recommend checking the unit once a year to assess proper function.  
Refer to troubleshooting page 11



## PRODUCT FEATURES

### TGV11S

#### Assembly

*Always keep the **TIMER** on **AUTO** mode to ensure proper functionality of the programs.*

Once unit is turned on for the first time, you will need to set up the timer to adjust current day and time. Also the timer button will allow you to set up programs and program review, as shown on page 10

**CAUTION:** **Suggested timer settings when installed in suction mode at end of drain line**  
(All settings are based on 3/4" drainpipe)

**NOTE:**

- For optimal performance install the solar module to maximize exposure to the sun. Do not program to run longer than 2 minutes per day for consecutive days, since unit can potentially overheat.
- **20 feet or less of drain pipe:**  
Program to run once a week for 2 minutes during mid day.  
Note: solar module needs direct unobstructed exposure to the sun for at least 2 hours a day to maintain battery voltage.
- **30 feet or less of drain pipe:**  
Program to run twice a week for 2 minutes during mid-day.  
Note: solar module needs direct unobstructed exposure to the sun for at least 3 hours a day to maintain battery voltage.
- Check battery periodically to insure module is properly charging and maintaining voltage at 12.8-13.5 VDC.
- In case of malfunction, always have an overflow switch installed as mandated by code. (Included with unit)
- the Green Vacuum, LLC will not be responsible by any damage caused to property if installation guidelines are not followed as suggested in this manual.

\* We recommend checking the unit once a year to assess proper function.  
Refer to troubleshooting page 11



# PRODUCT FEATURES

## TGV11S

### Assembly

Always keep the **TIMER** on **AUTO** mode to ensure proper functionality of the programs.

#### PROGRAMMING THE TIMER

**A.** Functional description to buttons on panel

**TIMER:** Programs review and setting programs

**MANUAL:** To select "ON, AUTO or OFF"

**CLOCK:** To adjust current **DAY** and **TIME**

**DAY:** To adjust day of the week

**HOUR:** To adjust the hour

**MIN:** To adjust the minutes

 Reset Timer's setting

**LED:** To indicate **ON/OFF** status

Press  button to reset Timer before programming



**B.** Adjusting **CLOCK**

Press and hold **CLOCK** and then press

**DAY** key, **HOUR** key, **MIN** key respectively to adjust clock of Timer to accurate **DATE, HOUR, MINUTE**. In 24-Hour-Format LCD screen shall indicate **0:00-23:59**

**C.** Start to program the **TIMER**

1. Press **TIMER** key, **LCD** screen shall show  
1 ON -- : -- \_ \_
2. Press **DAY** key to select any of 15-combination of Daily-Programs to your application demand. Continuing to press **DAY** key, LCD shall alternate indicating among 15-combinations.
3. Press **HOUR, MIN** respectively to set desired Hour and Minute for 1ON  
1 OFF -- : -- \_ \_
4. After setting 1ON, Press **TIMER** key again and 1OFF shall appear on the LCD screen.
5. Press **DAY** key to select any of 15-combination of Daily-Programs to your application demand. Continue pressing **DAY** key, **LCD** shall alternate indicating among 15-combinations.

DAY-COMBINATION CHOSEN IN EACH OF **ON/OFF** PROGRAM-PERIOD MUST BE CONSISTENT.

6. When finished setting 1ON and 1OFF, press **CLOCK**; timer shall start to execute programs.
7. Repeat Programming procedure "C" to set desired Hour and Minutes for all other programs.

**D.** To review programs

Press **TIMER** key to display among each of 6 or 8 **ON/OFF** programs.

\* We recommend checking the unit once a year to assess proper function.  
Refer to troubleshooting page 11



# Maintenance

## **IMPORTANT:**

To assure **SAFETY** and **RELIABILITY**: repairs, maintenance and adjustment (other than those listed in this manual) should be performed by authorized service centers or other qualified service personnel, always using identical replacement parts.

## **Troubleshooting**

If unit is not working: check fuse, reset timer and reprogram.

For further assistance with your product, visit our website [www.thegreenvacuum.com](http://www.thegreenvacuum.com) or call our toll free number 1-855-674-0413 or email us at [support@thegreenvacuum.com](mailto:support@thegreenvacuum.com)

To check proper functionality, manually test the unit yearly by pressing the **MANUAL** button in front of the timer to the **ON** position, once you checked the unit is properly functioning press the **MANUAL** button again to the **AUTO** position.

If the unit does not turn on when the **ON** position, check the fuse or exchange with included fuse, as shown in page 7, Figure F.

## **Accessories**

Recommended accessories for use with your product are available from your local dealer. If you need assistance regarding accessories, please call 1-855-674-0413 or visit us at [www.thegreenvacuum.com/store](http://www.thegreenvacuum.com/store)

## **Service Information**

At The Green Vacuum, LLC. our staff is trained to provide customers with efficient and reliable service. Whether you need technical advice, repair or genuine factory replacement parts, contact The Green Vacuum at 1-855-674-0413 or visit [www.thegreenvacuum.com](http://www.thegreenvacuum.com)



# Limited Warranty

## Limited Warranty for Repair or Replacement:

Thank you for purchasing the Green Vacuum® for your home. The Green Vacuum, LLC strives to provide a product that meets the highest standards of excellence and quality control. In an effort to make sure that you are satisfied with the Green Vacuum® purchase, we are granting a five (5) year limited warranty for any purchases of the Green Vacuum® purchased directly from The Green Vacuum, LLC and any authorized vendors, distributors, wholesalers, retailers, and any other authorized entity with rights to sell the product.

## What does this limited warranty cover?

This limited warranty covers any malfunction or defect caused by faulty material or workmanship for any components of the unit purchased through any authorized entities previously listed. This limited warranty does not cover any malfunctions or defects caused by faulty material or workmanship for any units purchased from unauthorized entities as determined by The Green Vacuum, LLC.

## Limited Warranty Term and Limitations

This limited warranty last for five (5) years from the date of purchase. Do not remove any product labels or warranty will void. Should the labels be removed, broken, altered or replaced, the Limited Warranty will be void. The limited warranty will be void should user operate unit outside of suggested timer settings. Please refer to suggested timer settings on page 9.

The duration of any implied warranties of merchantability, fitness for a particular purpose, good and workmanlike performance or service, or otherwise on this product are limited to the duration of the express warranty set forth in this section, which is five (5) years from the date of purchase.

The Green Vacuum, LLC shall not be liable for any consequential or incidental damages that arise out of the installation, use, or operation of this unit or out of the breach of any express or implied warranty. Purchasing a unit from any other source other than an authorized entity as determined by The Green Vacuum, LLC renders this express and any implied warranties void. Any alterations or removal of serial numbers or other identifying marks of the unit or packaging will void the warranty.

## Exclusions

This limited warranty does not cover the battery. This limited warranty does not cover normal wear and tear. Further, this limited warranty does not cover damage caused by negligence, misuse, tampering, alteration, failure to follow safety and/or warning instructions, failure to follow maintenance and/or operation instructions, and failure to follow troubleshooting instructions in case of malfunction.

## Limited Warranty Claim

When a claim is made to The Green Vacuum, LLC, upon determining that the limited warranty applies, we will repair or replace your unit at no cost except required shipping and handling costs. The repaired or replaced unit is warranted for the remainder of the original five (5) year limited warranty term. Should the exact unit no longer be available, it will be replaced with a comparable unit.



# Limited Warranty

## Claims Procedure for Domestic Returns

1. Save the original receipt.
2. For retail consumers who purchased from authorized vendors, distributors, wholesalers, retailers, and any other authorized entity with rights to sell the product please complete the Limited Warranty Card provided with the unit. Send the unit along with the Limited Warranty Card and original receipt and a check for \$20.00 for shipping and handling to the following address:  
4522 W Village Dr. Suite 202 Tampa, FL 33624.  
We strongly recommend tracking your shipment using UPS, Federal Express, or registered mail and keeping the tracking number for your records. You are responsible for the shipping charges to send your unit to The Green Vacuum, LLC. The Green Vacuum, LLC is not responsible for lost or stolen items or units lost during shipment to The Green Vacuum, LLC.
3. Contact The Green Vacuum, LLC customer service at 855-674-0413 or email us at [support@thegreenvacuum.com](mailto:support@thegreenvacuum.com) if you have any questions regarding your claim.

### FREE WARNING LABEL REPLACEMENT:

If your warning labels become illegible or are missing, call 1-855-674-0413 for a free replacement.

## International Returns:

*This warranty does not apply to products sold outside the U.S.A.*

## Application of State Law

This limited warranty gives you specific legal rights, but you may also have other rights that may vary from state to state.

## Governing Law

The Green Vacuum, LLC is a Florida Limited Liability Company governed by the laws of Florida. Any action against The Green Vacuum, LLC and any subsidiaries or assigns shall be brought in Florida and be governed by Florida law. Any disputes arising out of this limited warranty shall be brought in Florida and be governed by Florida Law. For purposes of venue, all actions shall be brought in Thirteenth Judicial Circuit of Hillsborough County Florida or the United States District Court for the Middle District of Florida.

**WARRANTY CARD**  
**KEEP THIS CARD IF REPAIR OR REPLACEMENT IS NEEDED**

For unit repair or replacement, please send the following:

- Completed Warranty Card
- Your unit
- Original receipt indicating the place and date of purchase
- \$20.00 USD check or money order payable to The Green Vacuum, LLC. to cover the shipping and handling.

**IMPORTANT:** Pack carefully in original carton if possible. We are not responsible for damage incurred in returning items for repair.

Attention: Service Center  
The Green Vacuum, LLC.

**Mail to:** 4522 W. Village Dr. Suite 202  
Tampa, FL 33624

Name: \_\_\_\_\_ Address: \_\_\_\_\_

\_\_\_\_\_ City: \_\_\_\_\_ State/Prov: \_\_\_\_\_

Zip Code: \_\_\_\_\_ E-mail: \_\_\_\_\_ Phone: \_\_\_\_\_

Model: \_\_\_\_\_ Dealer Purchased From: \_\_\_\_\_

City: \_\_\_\_\_ State/Prov: \_\_\_\_\_ Zip Code: \_\_\_\_\_

Date of Purchase: \_\_\_\_\_ Describe Problem: \_\_\_\_\_

\_\_\_\_\_

\_\_\_\_\_



KEEP FOR YOUR RECORDS

Shipping Tracking Number: \_\_\_\_\_

Date unit was sent: \_\_\_\_\_

**TECHNICAL SUPPORT HOTLINE**

Our technical department will gladly answer any questions you may have about our products. They can not however tell you the status of a repair or handle other customer service situations.

**1-855-674-0413**

Monday through Friday, 9:00AM to 5:00PM Eastern Time.



the Green Vacuum®

Printed in U.S.A.

© Copyright 2015 The Green Vacuum, LLC.

The information contain herein is subject to change without notice. The warranties for The Green Vacuum, LLC. products and services are set forth in the express warranty statements accompanying such products and services. Nothing herein should be construed as constituting an additional warranty. The Green Vacuum, LLC. shall not be liable for technical or editorial errors or omissions contained herein.

Revised Oct. 2015

